

EAD ONLINE CLASSES

Objective Book for

Electrical-JE

Electronics-JE

ITI-Electrician

JE Short Notes

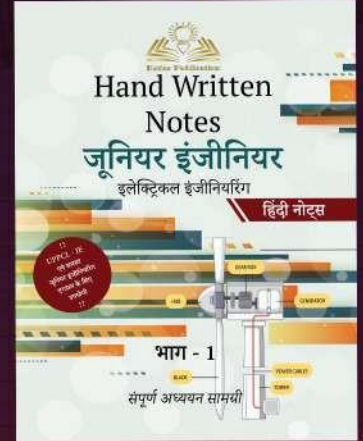
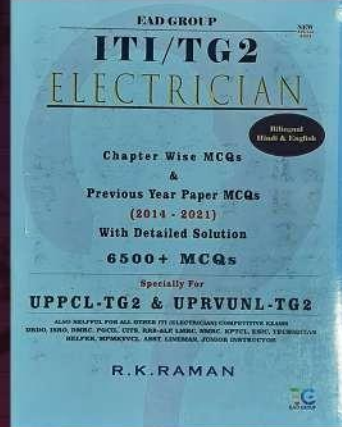
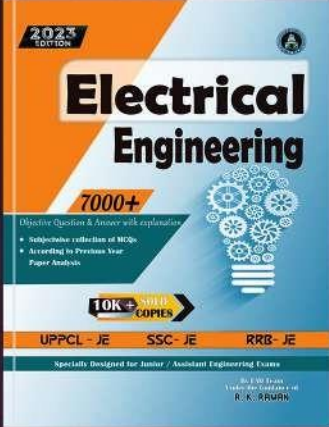

Buy our Books at:-

 **eadbooks.in**
 **Amazon**

Exam Targeted:-

**UPPCL-JE, SSC-JE RRB-JE
PGCIL-DT,DFCCIL-JE, ITI Etc.**



Raman sir
Electrical Engg. Expert

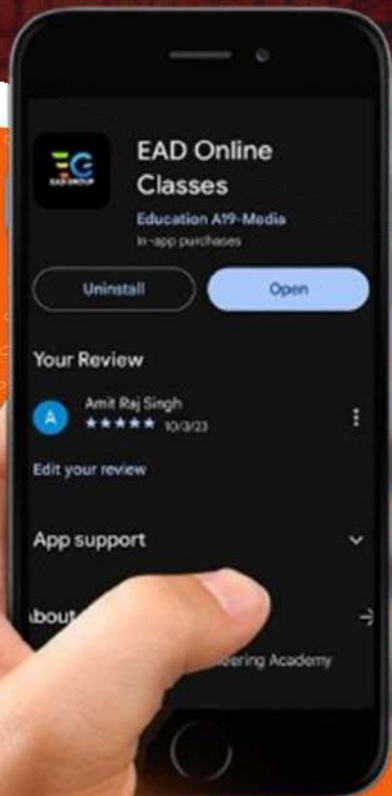

LOCATION

DEHRADUN CENTRE

EAD Educational Group, Pithuwalan kalan, Dehradun (UK)

PRAYAGRAJ CENTRE

EAD Educational Group, Horizon public school, Pandey Tower, Om gayatari nagar, Near shiv chowraha, Salori Prayagraj (UP)

Contact us:-

9389976136

Download EAD Online Classes application on playstore



EAD GROUP



EAD GROUP



Uttar Pradesh Power Corporation Limited

Electricity Service Commission, Uttar Pradesh Power Corporation Ltd. S.L.D.C campus, near Mantri Awas, Vibhuti Khand Phase-2, Gomti Nagar, Lucknow-226010

Participant ID	
Participant Name	
Test Center Name	
Test Date	25/03/2021
Test Time	2:30 PM - 5:30 PM
Subject	Junior Engineer (Trainee) Electronics or Tele Communication

Section : Domain Knowledge

Q.1 Which of the following is NOT true about self-dual function?Ans

- 1. The function must be a neutral function.
- 2. The function must be equal to its dual.
- 3. The function must not contain any mutually exclusive terms.
- 4. The function must contain 'n' mutually exclusive terms.

Question ID : 5038903896

Status : Answered

Chosen Option : 1

Q.2 The relationship between current, voltage and resistance $V=I \cdot R$ was introduced by __ in the year 1827.

- Ans
- 1. Kirchoff
 - 2. Kirby
 - 3. Norton
 - 4. Ohm

Question ID : 5038903917

Status : Answered

Chosen Option : 4

Q.3 _____ is a measuring device which can evaluate and record the electrical power passing through a circuit in a certain time. By implementing it, we can know how much amount of electrical energy is used by a consumer or a residence or an electrically powered device or a business.

- Ans
- 1. DC meter
 - 2. Air flow meter
 - 3. Watt hour meter
 - 4. AC meter

Question ID : 5038903891
Status : Answered
Chosen Option : 3

Q.4 _____ is a device that converts the thermal quantity into any physical quantitiesuch as mechanical energy, pressure and electrical signals.

- Ans
- 1. Photometer
 - 2. Current meter
 - 3. Temperature transducer
 - 4. Volta meter

Question ID : 5038903892
Status : Answered
Chosen Option : 3

Q.5 Find the odd one.

- Ans
- 1. Flip flops
 - 2. Microprocessors
 - 3. Op amps
 - 4. Counters

Question ID : 5038903890
Status : Answered
Chosen Option : 3

Q.6 The power amplifiers or the power combiners, when operated at or near saturation for maximum power efficiency, are nonlinear. The nonlinearities cause signal spreading in the frequency domain and generate intermodulation (IM) frequencies. The given phenomenon is associated with:

- Ans
- 1. OFDMA
 - 2. FDMA
 - 3. TDMA
 - 4. CDMA

Question ID : 5038904018
Status : Not Answered
Chosen Option : --

Q.7 Which of the following is NOT an application of thermistors? Ans

- 1. Household appliances (like microwaves, fridges, and ovens)
- 2. Automotive applications (to measure oil and coolant temperatures in cars and trucks)
- 3. Dischargeable batteries
- 4. Digital thermometers (thermostats)

Question ID : 5038904023
Status : Answered
Chosen Option : 3

Q.8 Identify the correct condition for an even signal. Ans

- 1. $X(t) = X(n)$
- 2. $X(t) = -X(-t)$
- 3. $X(t) = X(-t)$
- 4. $X(t) = X(t+n)$

Question ID : 5038903898
Status : Answered
Chosen Option : 3

Q.9 A microcontroller can be considered a self-contained system with a processor, _____ and peripherals, and can be used as an embedded system.

Choose the most appropriate option.

- Ans
- 1. Keyboard
 - 2. memory
 - 3. Tester
 - 4. pre-processor

Question ID : 5038903957
Status : Answered
Chosen Option : 2

Q.10 Find the cutoff frequency of dominant mode in an air-filled circular waveguide having inner radius of 1 cm which is excited in dominant mode at 12 GHz.

- Ans
- 1. 10 GHz
 - 2. 3.5 GHz
 - 3. 6.5 GHz
 - 4. 8.795 GHz

Question ID : 5038903974
Status : Not Attempted and Marked For Review
Chosen Option : --

Q.11 Select the option that is true regarding the following two statements labelled Assertion (A) and Reason (R).

Assertion (A): In everyday use, a 5V AC supply means 5 V RMS with the peak voltage about 7 V.

Reason (R): In everyday use, AC voltages (and currents) are always given as RMS values because this allows a sensible comparison to be made with steady DC voltages (and currents), such as from a battery.

- Ans
- 1. Both A and R are true, and R is a correct explanation of A
 - 2. A is true but R is false
 - 3. Both A and R are true but R is not a correct explanation of A
 - 4. A is false but R is true

Question ID : 5038903927

Status : Answered

Chosen Option : 1

Q.12 The capacity of a cellular system in fixed area is directly proportional to which of the following?

- Ans
- 1. Number of directional antennas
 - 2. Number of times a cluster is replicated
 - 3. Number of users
 - 4. Number of base stations

Question ID : 5038904010

Status : Not Answered

Chosen Option : --

Q.13 Calculate the dependent source voltage $V(b)$ in the given circuit.

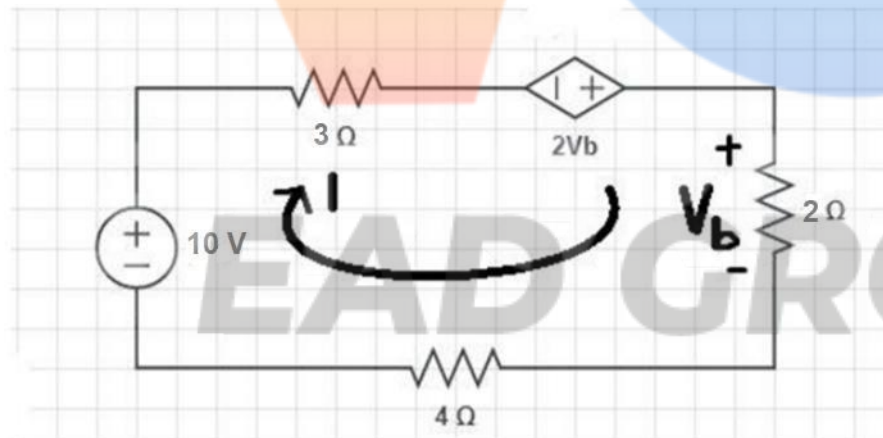

- Ans
- 1. 2 V
 - 2. 4 V
 - 3. 8 V
 - 4. 20 V

Question ID : 5038903929

Status : Answered

Chosen Option : 2

Q.14 The traffic in a telecommunication network is measured by an internationally accepted unit of traffic intensity. Select the correct option.

- Ans
- 1. Decibel
 - 2. Decimal
 - 3. Degree
 - 4. Erlang

Question ID : 5038903996
Status : Not Answered
Chosen Option : --

Q.15 What will be the output of the following code?

```
#include <string.h>
#include <stdio.h>
int main()
{
    char p[]="assignment";
    char t;
    int i,j;
    for(i=0,j=strlen(p); i<j; i++)
    {
        t=p[i];
        p[i]=p[j-i];
        p[j-i]=t;
    }
    printf("%s",p);
    return 0;
}
```

- Ans
- 1. Assignment
 - 2. Nothing is printed
 - 3. Tnemngissa
 - 4. Ttttttt

Question ID : 5038903887
Status : Not Answered
Chosen Option : --

Q.16 The process of communicating using fibre-optics involves basic steps. Arrange the steps in the correct order.

- (a) relaying the signal along the fibre
- (b) creating the optical signal involving the use of a transmitter
- (c) receiving the optical signal
- (d) converting it into an electrical signal

- Ans
- 1. a - b - c - d
 - 2. b - a - c - d
 - 3. d - a - c - b
 - 4. c - b - a - d

Question ID : 5038903990
Status : Answered
Chosen Option : 4

Q.17 Select the option that is true regarding the following two statements labelled Assertion (A) and Reason (R).

Assertion (A): There is a pair of magnetic forces acting on a current carrying coil in a magnetic field. These two forces cause a deflection of the coil counter clockwise, i.e. the galvanometer's hand deflects leftwards.

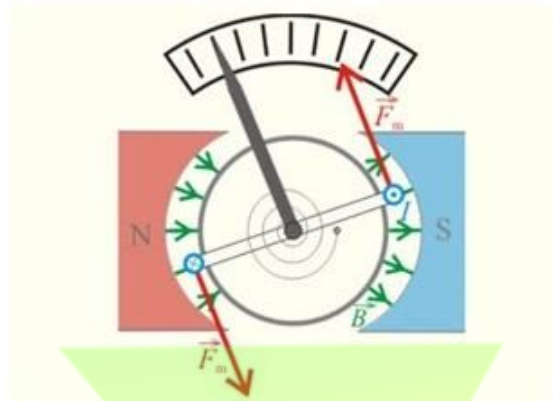

Reason (R): The direction of the magnetic forces acting on the coil with current can be found using Fleming's left-hand rule. Refer the figure given to help in deducing answer.

- Ans
- 1. A is false but R is true
 - 2. Both A and R are true, but R is not a correct explanation of A
 - 3. A is true but R is false
 - 4. Both A and R are true and R is the correct explanation of A

Question ID : 5038903985
Status : Answered
Chosen Option : 4

Q.18 _____ is a function for which the number of minterms and number of maxterms are same.

- Ans
- 1. Self dual
 - 2. Boolean
 - 3. Neutral
 - 4. Universal

Question ID : 5038904027
Status : Answered
Chosen Option : 2

Q.19 Which of the following is NOT true about thermistor and resistance temperature detectors?

- Ans
- 1. Thermistors are more accurate and cheaper than RTDs.
 - 2. Thermistors have faster response time than RTDs.
 - 3. Thermistors can measure temperature over a wider range than RTDs
 - 4. Thermistors are commonly made with ceramic or polymer materials while RTDs are made of pure metals.

Question ID : 5038904030
Status : Answered
Chosen Option : 4

Q.20 Which of the following is NOT true for a parallel DC circuit?

- Ans
- 1. Total circuit current is the arithmetic sum of the currents passing through individual components connected in parallel.
 - 2. The reciprocal of equivalent resistance is equal to the sum of the reciprocals of the resistances of individual components connected in parallel.
 - 3. Current through individual components connected in parallel is directly proportional to their resistances.
 - 4. Voltage drops are the same across all the components connected in parallel.

Question ID : 5038903922
Status : Answered
Chosen Option : 3

Q.21 In the year 1993, _____ introduced the first microcontroller using flash memory. Ans

- 1. Atmel
- 2. Intel
- 3. Alchemist
- 4. Ericson

Question ID : 5038903959
Status : Answered
Chosen Option : 2

Q.22 Which of the following is NOT true about SWR? Ans

- 1. $VSWR = \frac{V_{max}}{V_{min}}$
- 2. $VSWR = \frac{V_{fwd} + V_{ref}}{V_{fwd} - V_{ref}}$
- 3. ISWR meter can measure current SWR and VSWR can measure voltage SWR.
- 4. Standing waves are also known as stationary waves in physics.

Question ID : 5038904029
Status : Answered
Chosen Option : 3

Q.23 What is the output after two clock pulses for a bit sequence 1101 serially entered into a 4-bit parallel out shift register which is initially clear?

- Ans
- 1. 0011
 - 2. 1010
 - 3. 1100
 - 4. 0100

Question ID : 5038903903
Status : Answered
Chosen Option : 2

Q.24 Find the odd one from the following. Ans

- 1. Real Time Embedded Systems
- 2. Stand-Alone Embedded Systems
- 3. Networked Embedded Systems
- 4. Static Embedded Systems

Question ID : 5038903963
Status : Answered
Chosen Option : 2

Q.25 Variable losses in the motor consist of:

- Ans
- 1. resistance loss in stator and in rotor
 - 2. magnetic core losses
 - 3. friction loss
 - 4. aerodynamic loss

Question ID : 5038903939
Status : Answered
Chosen Option : 2

Q.26 Find the vertical and horizontal resolutions, respectively, used in a TV system in USA where
NT = 525, NL = 42.

- Ans
- 1. 365, 847
 - 2. 338, 451
 - 3. 409, 546
 - 4. 245, 547

Question ID : 5038903895
Status : Not Answered
Chosen Option : --

Q.27 निम्नलिखित में से कौन सा विकल्प सत्य है?

- Ans
- 1. निष्क्रिय फिल्टर उत्कृष्ट वियोजन प्रदान करते हैं
 - 2 सक्रिय फिल्टर आकार में छोटे और कम भारी होते हैं
 - 3. निष्क्रिय फिल्टर में ऑप-एम्प और ट्रांजिस्टर होते हैं
 - 4. निष्क्रिय फिल्टर आकार में छोटे और कम भारी होते हैं

Question ID : 5038903981
Status : Answered
Chosen Option : 2

Q.28 Study the given figures.

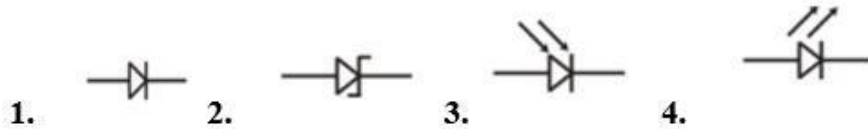

Identify the elements from 1 to 4 and select the option that shows their correct names.

- Ans
- 1. 1: Zener diode, 2: Photo diode, 3: LED diode, 4: Junction diode
 - 2. 1: LED diode, 2: Junction diode, 3: Zener diode, 4: Photo diode
 - 3. 1: Photo diode, 2: LED diode, 3: Junction diode, 4: Zener diode
 - 4. 1: Junction diode, 2: Zener diode, 3: Photo diode, 4: LED diode

Question ID : 5038903926
Status : Answered
Chosen Option : 4

Q.29 Which of the following is an application of Ohm's Law? Ans

- 1. Thyristor
- 2. Transistor
- 3. Diode
- 4. DC Ammeter

Question ID : 5038903925
Status : Answered
Chosen Option : 3

Q.30 Identify the disadvantage of Bluetooth technologies from the given options. Ans

- 1. Used for voice and data transfer
- 2. Low power consumption
- 3. Affordable rates
- 4. Lower security

Question ID : 5038904012
Status : Answered
Chosen Option : 4

Q.31 RC कला विस्थापन दोलक में तीन RC अग्रग जालक्रम का कुल कला विस्थापन ____ होता है।

- Ans
- 1. 360°
 - 2. 90°
 - 3. 180°
 - 4. 0°

Question ID : 5038903980
Status : Answered
Chosen Option : 3

Q.32 Select the INCORRECT statement about TDMA from the following options. Ans

- 1. High transmission rates
- 2. Discontinuous data transmission
- 3. Single carrier frequency for single user
- 4. No requirement of duplexers

Question ID : 5038904017
Status : Answered
Chosen Option : 1

Q.33 For a series DC circuit, which of the following does NOT hold true?

- Ans
- 1. When a number of electrical components are connected in series, the same current flows through all the components of the circuit.
 - 2. The applied voltage across a series circuit is equal to the sum total of voltage drops across each component.
 - 3. The voltage drop across individual components is directly proportional to its resistance value.
 - 4. Total circuit current is the arithmetic sum of the currents passing through individual components connected in parallel.

Question ID : 5038904032
Status : Answered
Chosen Option : 4

Q.34 The point of location of a short-circuited stub on the line is given by:

- Ans
- 1. $\frac{\phi - \pi \mp \cos^{-1}|K|}{2\pi} \cdot \frac{\lambda}{4}$
 - 2. $\frac{\phi + 2\pi \mp \cos^{-1}|K|}{2\pi} \cdot \frac{\lambda}{4}$
 - 3. $\frac{\pi \mp \cos^{-1}|K|}{\pi} \cdot \frac{\lambda}{2}$
 - 4. $\frac{\phi + \pi \mp \cos^{-1}|K|}{\pi} \cdot \frac{\lambda}{4}$

Question ID : 5038903982
Status : Not Answered
Chosen Option : --

Q.35 The number of channels in a TDMA system is given by:

Ans

1. $N = \frac{m(2B_{\text{Tot}} - B_{\text{guard}})}{B_c}$

2. $N = \frac{m(B_{\text{Tot}} - 2B_{\text{guard}})}{B_c}$

3. $N = \frac{m(B_{\text{Tot}} - 2B_{\text{guard}})}{2B_c}$

4. $N = \frac{2m(B_{\text{Tot}} - B_{\text{guard}})}{B_c}$

Question ID : 5038904009

Status : Not Answered

Chosen Option : --

Q.36 The highest priority interrupt in 8085 is:

Ans

1. TRAP

2. RST6.5

3. INTR

4. RST7.5

Question ID : 5038904022

Status : Answered

Chosen Option : 1

Q.37 What will be the output of the following?

```
#include
using namespace std;

int main()
{
    int arr[] = { 11, 51, 81, 91, 61, 71, 31, 41, 21};
    int n = sizeof(arr) / sizeof(arr[0]);sort(arr,
    arr + n, greater());
    cout << "Output Array : \n";for
    (int i = 0; i < n; ++i)
        cout << arr[i] << " ";

    return 0;
}
```

Ans

1. 0

2. Abnormal termination of program

3. 11 21 31 41 51

4. 91 81 71 61 51 41 31 21 11

Question ID : 5038904004

Status : Not Answered

Chosen Option : --

Q.38 Match the columns.

Pin	Description
a. D_0-D_7	1. Reset Input
b. RESET	2. Data Lines
c. A_0,A_1	3. Internal Address

- Ans
- 1. a-2, b-1, c-3
 - 2. a-1, b-2, c-3
 - 3. a-2,b-3, c-1
 - 4. a-1, b-3, c-2

Question ID : 5038903967
Status : Answered
Chosen Option : 1

Q.39 If a total of 33 MHz of bandwidth is allocated to a particular FDD cellular telephone system which uses two 25 kHz simplex channels to provide full duplex voice and control channels, compute the number of channels available per cell if a system uses 4-cell reuse.

- Ans
- 1. 55
 - 2. 660
 - 3. 95
 - 4. 165

Question ID : 5038904011
Status : Not Answered
Chosen Option : --

Q.40 Out of the following, which light is used for the optical fibre communication? Ans

- 1. Tube light
- 2. Laser light
- 3. Bulb light
- 4. Sunlight

Question ID : 5038903987
Status : Answered
Chosen Option : 2

Q.41 In all fuel types, primary energy content is generally expressed in terms of:Ans

- 1. Megawatt
- 2. Joules
- 3. Kilowatt
- 4. Toe

Question ID : 5038903942
Status : Answered
Chosen Option : 3

Q.42 Find the minimum sampling rate for band pass consideration of the following signal to be truthfully represented by its samples:

$$m(t) = 2\cos 6000 \pi t + 4\cos 8000 \pi t + 6\cos 10000 \pi t$$

- Ans
- 1. 10 kHz
 - 2. 3 kHz
 - 3. 6 kHz
 - 4. 5 kHz

Question ID : 5038904000
Status : Answered
Chosen Option : 3

Q.43 Prakash Power Ltd. set up a factory for manufacturing jute bags in a remote village. The revenue earned by the company was sufficient to cover the costs and the risks. As the demand of jute bags was increasing day- by-day, the company decided to increase production to generate higher sales. For this, they decided to employ people from a nearby village as very few job opportunities were available in that area. The company also decided to open schools and creches for the children of its employees. Which objectives were accomplished by the company?

- Ans
- 1. Organisational objectives and social objectives
 - 2. Selfish objectives
 - 3. Personal and organisational objectives
 - 4. Social objectives and personal objectives

Question ID : 5038903941
Status : Answered
Chosen Option : 1

Q.44 Some of the properties of a microwave are mentioned here. Select the incorrect option.

- Ans
- 1. Microwaves are reflected by Ionosphere.
 - 2. Microwaves travel in a straight line and are reflected by the conducting surfaces.
 - 3. Microwaves are the waves that radiate electromagnetic energy with shorter wavelength.
 - 4. Microwave currents can flow through a thin layer of a cable.

Question ID : 5038903977
Status : Answered
Chosen Option : 3

Q.45 Deflecting torque in moving iron instruments is given by:

Ans

- 1. $\frac{1}{2} LI^2$
- 2. $\frac{1}{2} I^2 \frac{dL}{d\theta}$
- 3. $\frac{1}{4} I^2$
- 4. $2 LI^2$

Question ID : 5038903937
Status : Answered
Chosen Option : 2

Q.46 The calling vector address in HEX for RST 5 instruction is:

Ans

- 1. 0028
- 2. 0018
- 3. 0030
- 4. 0020

Question ID : 5038903970
Status : Answered
Chosen Option : 1

Q.47 _____, समय के सन्दर्भ में एक विद्युत अवयव द्वारा उपभुक्त या आपूर्ति ऊर्जा की दर होती है।

Ans

- 1. वोल्टता
- 2. शक्ति
- 3. धारा
- 4. आवृत्ति

Question ID : 5038903918
Status : Answered
Chosen Option : 2

Q.48 Predict the output of the following C code:

```
##include  
int main()  
{  
    enum ball {tennis, base, basket ,root},  
    enum sports {cricket, tennis};  
  
    int a = 0;  
    for(a = tennis; a <= root; a++)  
    {  
        printf("%d ", a);  
    }  
  
    return 0;  
}
```

- Ans
- 1. cricket, tennis
 - 2. compiler error
 - 3. foot, basket, base, tennis
 - 4. tennis, base, basket; foot

Question ID : 5038904006
Status : Not Answered
Chosen Option : --

Q.49 Find the odd one.

Ans

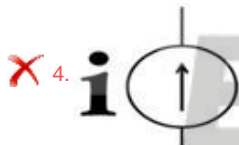
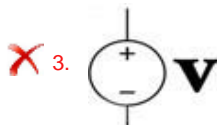
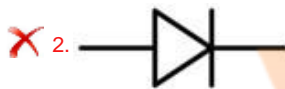

Question ID : 5038904026
Status : Answered
Chosen Option : 1

Q.50 Which of the following does not describe/is not the correct phrase to describe C programming language?

- Ans
- 1. Case insensitive
 - 2. Procedural
 - 3. Middle level
 - 4. Modular

Question ID : 5038904002
Status : Not Attempted andMarked
For Review
Chosen Option : --

Q.51 From the given options select the labels missing in the diagram.

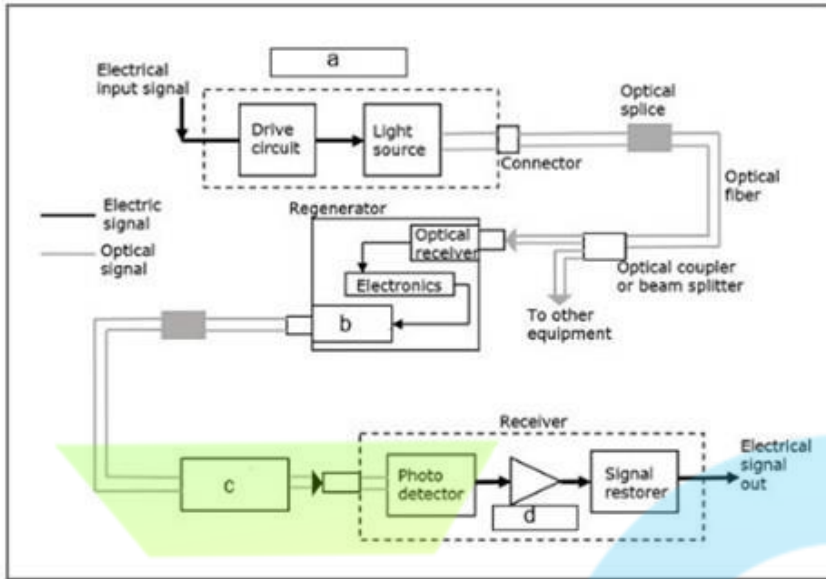

- Ans
- 1. Amplifier, optical amplifier, optical transmitter, transmitter
 - 2. Optical amplifier, amplifier, transmitter, optical transmitter
 - 3. Transmitter, optical transmitter, optical amplifier, amplifier
 - 4. Optical transmitter, transmitter, amplifier, optical amplifier

Question ID : 5038903992
 Status : Not Answered
 Chosen Option : --

Q.52 Which of the following is the correct way of constructing character constants? Ans

- 1. 'B'
- 2. "B"
- 3. 'B'
- 4. `B`

Question ID : 5038903884
 Status : Answered
 Chosen Option : 2

Q.53 Pitot tubes are used to check:

- Ans
- 1. Measure gases
 - 2. Air velocity in ducts
 - 3. Mass calculation
 - 4. Surface temperatures

Question ID : 5038903940
 Status : Answered
 Chosen Option : 2

Q.54 Identify the given circuit diagram.

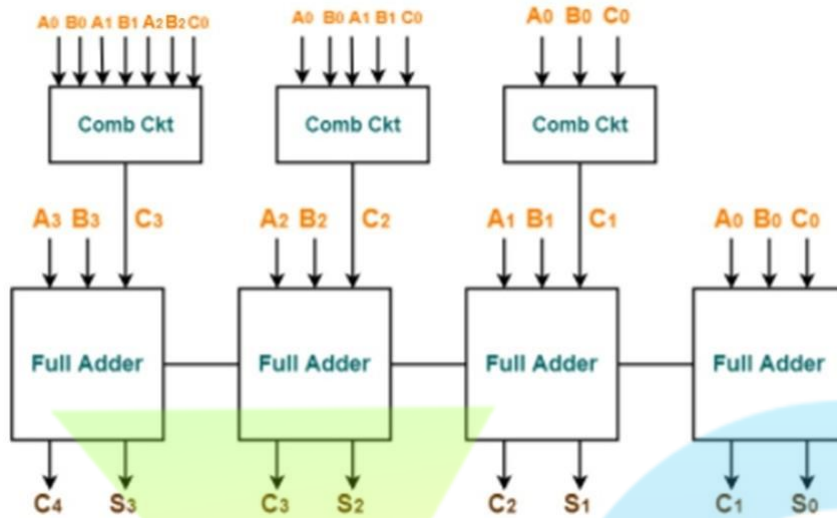

- Ans
- 1. Full adder
 - 2. Half adder
 - 3. Carry look ahead adder
 - 4. Ripple carry adder

Question ID : 5038903899
 Status : Answered
 Chosen Option : 3

Q.55 निम्नलिखित में से असंगत का चयन करें।
 संकेत: परिधीय उपकरण

- Ans
- 1. माउस
 - 2. कीबोर्ड
 - 3. ROM
 - 4. वेबकैम

Question ID : 5038903979
 Status : Answered
 Chosen Option : 3

Q.56 What does the given symbol represent?



- Ans
- 1. Motor AC and DC
 - 2. Ampere meter
 - 3. Generator DC
 - 4. Generator AC

Question ID : 5038903907
 Status : Answered
 Chosen Option : 4

Q.57 Calculate the resistance as per the given colour code.



Ans

1. $345 \times 10^3 \Omega$
2. $345 \times 10^1 \Omega \pm 10\%$
3. 345Ω
4. $345 \times 10^{-1} \Omega + 10\%$

Question ID : 5038903936
Status : Answered
Chosen Option : 2

Q.58 Which of the following is NOT an advantage of a hot carrier diode? Ans

1. Low turn on voltage
2. Low reverse voltage rating
3. Voltage drop is low
4. Low junction capacitance

Question ID : 5038903914
Status : Answered
Chosen Option : 2

Q.59 जब एक अज्ञात प्रतिरोध को 100-वाट, 250 V लैप के साथ 250 V आपूर्ति में समानांतर स्थिति में जोड़ा जाता है, तो इसके मान की गणना करें (यह मान कर कि लैप का प्रतिरोध अपरिवर्तित रहता है); परिपथ में कुल क्षयित शक्ति 1100 वाट है।

- Ans
1. 38Ω
 2. 62.5Ω
 3. 24Ω
 4. 20Ω

Question ID : 5038903906
Status : Answered
Chosen Option : 2

EAD GROUP

Q.60 For the figure shown, each flip flop has a propagation delay of 10 ns. Determine the total propagation delay from the triggering edge of a clock pulse until a corresponding change can occur in the state of Q_3 .

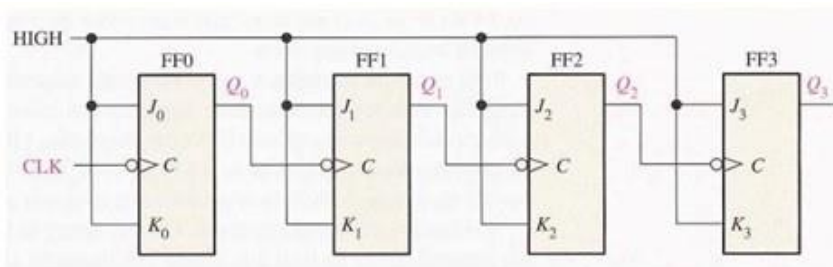

- Ans
- 1. 20 ns
 - 2. 10 ns
 - 3. 30 ns
 - 4. 40 ns

Question ID : 5038903902
 Status : Answered
 Chosen Option : 4

Q.61 An optical fibre cable consists of three parts. One of these is a protective outer coating of the cable. Select that protective outer coating from the given options.

- Ans
- 1. Fibre
 - 2. Buffer coating
 - 3. Cladding
 - 4. Core

Question ID : 5038903993
 Status : Answered
 Chosen Option : 3

Q.62 Calculate the rejection ratio at 1000 kHz for a broadcast superheterodyne receiver having no RF amplifier. The loaded Q of the antenna coupling circuit is 100. Intermediate frequency is 455 kHz.

- Ans
- 1. 7.22
 - 2. 7.87
 - 3. 3.53
 - 4. 138.6

Question ID : 5038903997
 Status : Not Attempted and
 Marked For Review
 Chosen Option : --

Q.63 The base clock speed for 8085A microprocessor is:

- Ans
- 1. 5.0 MHz
 - 2. 3.0 MHz
 - 3. 3.5 MHz
 - 4. 2.5 MHz

Question ID : 5038903969
Status : Answered
Chosen Option : 2

Q.64 Which of the following statements is FALSE?

- Ans
- 1. Vertical resolution is double than that of PAL and SECAM systems
 - 2. NTSC system circuits are more complex than PAL and SECAM systems
 - 3. Studio mixing is easy
 - 4. Phase switching is not required in NTSC system

Question ID : 5038903893
Status : Not Answered
Chosen Option : --

Q.65 The most modern method of producing white light for TVs uses:

- Ans
- 1. aluminium gallium nitride
 - 2. gallium phosphide
 - 3. Ga arsenide
 - 4. zinc selenide crystal

Question ID : 5038903894
Status : Not Answered
Chosen Option : --

Q.66 Which of the following is NOT the correct representation of Power? Ans

- 1. $p = \frac{d\omega}{dt} \cdot \frac{dq}{dt}$
- 2. $p = vi$
- 3. $p = \frac{d\omega}{dt}$
- 4. $p = \frac{v}{i}$

Question ID : 5038903910
Status : Answered
Chosen Option : 4

Q.67 On 14 December 1988, the first transatlantic telephone cable to use optical fiber was

- Ans
- 1. TAT-5
 - 2. TAT-7
 - 3. TAT-8
 - 4. TAT-6

Question ID : 5038904015
Status : Not Answered
Chosen Option : --

Q.68 In LTE network architecture, the interface between internet and PDN gateway is: Ans

- 1. Um
- 2. SS7
- 3. S5
- 4. SGI

Question ID : 5038904019
Status : Not Answered
Chosen Option : --

Q.69 RTT is an effective and quick solution for sending alerts in case of emergencies. Types of text messaging can be email, SMS and instant message. What is the full form of RTT?

- Ans
- 1. Real Time Text Messaging
 - 2. Real Time Talk
 - 3. Real Tech Talk
 - 4. Real Tech Text

Question ID : 5038904014
Status : Answered
Chosen Option : 4

Q.70 Digital multimeter is used to perform 'Diode Check'. Which of the following is an unexpected reading for a good diode?

- Ans
- 1. When both the red and negative leads of the multimeter are connected to positive terminal of the diode, then we have to get a high reading on the multimeter.
 - 2. When the red lead of the multimeter is connected to positive terminal of the diode while its negative lead is connected to the negative terminal of the diode, then we have to get a low reading on the multimeter.
 - 3. When the red lead of the multimeter is connected to the negative terminal of the diode and the black to the positive terminal, then we have to get a low value.
 - 4. When the red lead of the multimeter is connected to positive terminal of the diode while its negative lead is connected to the negative terminal of the diode, then we have to get a high reading on the multimeter.

Question ID : 5038903904
Status : Answered
Chosen Option : 4

Q.71 Seema has two bulbs, one of them is faulty. She connects both the bulbs in parallel and not in series. Which of the following is NOT the correct reason to do this?

- Ans
- 1. In series, if there is a fault in one bulb, then the whole circuit will be affected.
 - 2. In parallel connection, both bulbs get exactly half amount of voltage in the battery.
 - 3. If there is a fault in one bulb, it can be removed or repaired. Thus, the whole circuit will not be affected.
 - 4. We can operate two bulbs separately in parallel connection.

Question ID : 5038903933
Status : Answered
Chosen Option : 2

Q.72 The given symbol shows:

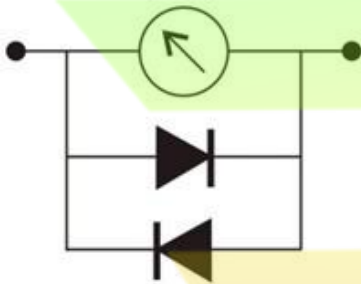

- Ans
- 1. single diode protection
 - 2. avalanche protection
 - 3. zener protection
 - 4. double diode protection

Question ID : 5038903920
Status : Answered
Chosen Option : 4

Q.73 Energy Conservation Day is celebrated in India on _____ every year since 1991, to make people aware of climate change and global warming by promoting efforts towards saving energy resources.

- Ans
- 1. 1 May
 - 2. 14 December
 - 3. 21 June
 - 4. 1 December

Question ID : 5038903944
Status : Answered
Chosen Option : 2

Q.74 The concept of infinite line deals with analysis of transmission of electric waves along any _____ and _____ transmission line in terms of an imaginary line having electrical constant per unit length.

- Ans
- 1. uniform, symmetrical
 - 2. non uniform, asymmetrical
 - 3. uniform, asymmetrical
 - 4. non uniform, symmetrical

Question ID : 5038903978

Status : Not Attempted and
Marked For Review

Chosen Option : --

Q.75 Arrange the needs from the lowest to highest hierarchy as per Maslow's theory.

- 1) Psychological needs
- 2) Safety and security needs
- 3) Social needs
- 4) Self-actualisation needs
- 5) Esteem and ego or status needs

- Ans
- 1. 1-2-3-4-5
 - 2. 1-2-3-5-4
 - 3. 3-4-5-1-2
 - 4. 2-3-4-5-1

Question ID : 5038903956

Status : Not Answered

Chosen Option : --

Q.76 The technique for decreasing co-channel interference and thus increasing system capacity by using directional antennas is called:

- Ans
- 1. Sectoring
 - 2. cell splitting
 - 3. cell merging
 - 4. micro zoning

Question ID : 5038904016

Status : Answered

Chosen Option : 1

Q.77

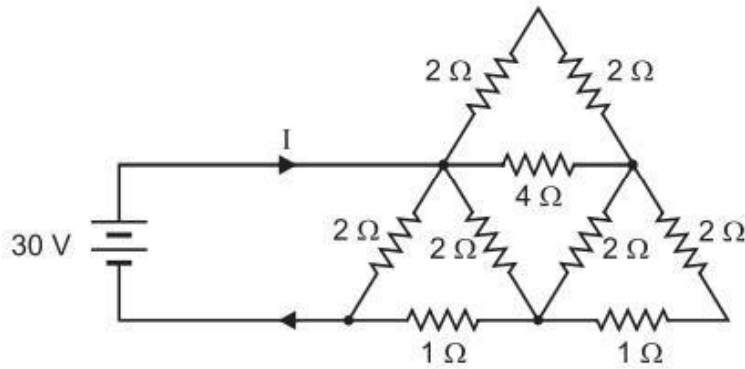

Find current supplied by the source.

- Ans
- 1. 28.45 A
 - 2. 18 A
 - 3. 22 A
 - 4. 23.5 A

Question ID : 5038903912

Status : Not Attempted and
Marked For Review

Chosen Option : --

Q.78 What will be the co-channel reuse ratio for a system where $i=j=2$? Ans

- 1. 1
- 2. 6
- 3. 8
- 4. 3

Question ID : 5038904013

Status : Not Answered

Chosen Option : --

Q.79 Colour subcarrier for PAL system is:

- Ans
- 1. 4.25 MHz
 - 2. 4.43 MHz
 - 3. 3.58 MHz
 - 4. 4.406 MHz

Question ID : 5038903889

Status : Not Answered

Chosen Option : --

Q.80 The measure of the ease with which magnetic flux can be admitted through a material or magnetic circuit is called _____.

- Ans
- 1. Permeance
 - 2. Reluctance
 - 3. Conductance
 - 4. magnetic flux

Question ID : 5038903911
Status : Answered
Chosen Option : 1

Q.81 What will be the value of 'i' after the execution of the given C code fragment?static char

```
str1[]="dills";  
static char str2[20];  
static char str3[]="daffo";int i;  
i=strcmp(strcat(str3,strcpy(str2,str1)),"daffodills");
```

 Ans

- 1. 0
- 2. -1
- 3. 1
- 4. 3

Question ID : 5038903886
Status : Not Answered
Chosen Option : --

Q.82 Ria needs to calculate the number of turns that a solenoid should have, in order to induce a voltage of 50 V provided that the magnetic flux in its cavity changes from 70 mWb to 20 mWb per time 0.20 s. What will be her answer?

- Ans
- 1. 50
 - 2. 2
 - 3. 20
 - 4. 200

Question ID : 5038903983
Status : Answered
Chosen Option : 4

Q.83 Which of the following statements is NOT true about semiconductor optical amplifiers?

- Ans
- 1. They provide high gain over wide spectral bandwidth
 - 2. They cannot be used for wideband amplification
 - 3. They can be integrated to produce subsystems
 - 4. They are small in size

Question ID : 5038903988
Status : Not Answered
Chosen Option : --

Q.84 _____, प्रबंधन के लिए एक मार्गदर्शिका के रूप में कार्य करता है, विशेष रूप से प्रारंभिक चरण में, यह जानने के लिए कि तकनीकी, वाणिज्यिक, वित्तीय और आर्थिक स्थिति संभव है या नहीं।

- Ans
- 1. रूपरेखा रिपोर्ट
 - 2. वित्तीय रिपोर्ट
 - 3. साध्यता रिपोर्ट
 - 4. योजना रिपोर्ट

Question ID : 5038903954
Status : Answered
Chosen Option : 1

Q.85 In PIC 16F877, a byte at a program memory address 0x0800 can be accessed directly by using:

- Ans
- 1. 10-bit page offset address 0x189 at page 1
 - 2. 10-bit page offset address 0x100 at page 0
 - 3. 11-bit page offset address 0x000 at page 0
 - 4. 11-bit page offset address 0x000 at page 1

Question ID : 5038903961
Status : Not Answered
Chosen Option : --

Q.86 A PIN diode consists of:

- Ans
- 1. heavily doped p region, lightly doped n region separated by a high resistivity material
 - 2. lightly doped p region, lightly doped n region separated by a low resistivity material
 - 3. heavily doped p and n regions separated by a high resistivity material
 - 4. heavily doped p region, lightly doped n region separated by a low resistivity material

Question ID : 5038903976
Status : Answered
Chosen Option : 4

Q.87 If LC components are used in the feedback path of an oscillator, the waveform generated is:

- Ans
- 1. sinusoidal wave at all frequencies
 - 2. triangular wave at all frequencies
 - 3. sinusoidal wave at radio frequencies
 - 4. square wave at radio frequencies

Question ID : 5038903916
Status : Answered
Chosen Option : 3

Q.88 असंगत जोत कर।

- Ans
- 1. PDA
 - 2. पेजर
 - 3. डिगित कंूटर
 - 4. पिसल

Question ID : 5038904008
Status : Answered
Chosen Option : 1

Q.89 _____ states that if an element in a network is replaced by a voltage/current source whose voltage/current at any instant of time is equal to the voltage/current across the element in the previous network then the initial condition in the rest of the network will be unaltered.

- Ans
- 1. Substitution Theorem
 - 2. Thevenin's Theorem
 - 3. Reciprocity Theorem
 - 4. Norton's Theorem

Question ID : 5038903930
Status : Answered
Chosen Option : 3

Q.90 The formula of angular momentum is $l = mvr$, where l is angular momentum, m is mass, v is velocity and r is radius. Hence, the dimensional formula of angular momentum is _____.

- Ans
- 1. ML^2T^{-1}
 - 2. $M2L^2T^{-1}$
 - 3. $ML^{-2}T^{-1}$
 - 4. ML^2T^{-2}

Question ID : 5038903947
Status : Answered
Chosen Option : 4

Q.91 Name the communication satellite which was successfully launched by India's PSLV-C50 on 17 December 2020.

- Ans
- 1. SLV-05
 - 2. SLV-01
 - 3. CMS-50
 - 4. CMS-01

Question ID : 5038903999
Status : Not Answered
Chosen Option : --

Q.92 Match the columns.

SI unit	Component
1. Amount of substance	a. ampere
2. Electric current	b. candela
3. Luminous intensity	c. mole
4. Plane angle	d. radian

- Ans
- 1. 1-c, 2-b, 3-d, 4-a
 - 2. 1-c, 2-b, 3-a, 4-d
 - 3. 1-c, 2-a, 3-b, 4-d
 - 4. 1-b, 2-c, 3-a, 4-d

Question ID : 5038903949
 Status : Answered
 Chosen Option : 3

Q.93 Calculate the value of current flowing through a conductor (at rest) when a straight wire 3m long (denoted as AB in the given figure) of resistance 3 ohm is placed in the magnetic field with magnetic induction of 0.3 T. The conductor is connected to a voltage source of 3V.

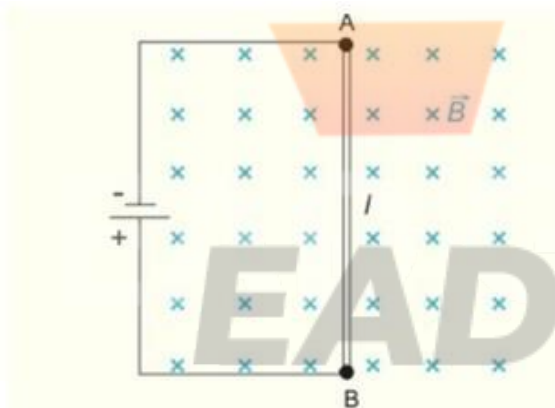

- Ans
- 1. $I = 9 \text{ A}$
 - 2. $I = 1 \text{ mA}$
 - 3. $I = 1 \text{ A}$
 - 4. $I = 3.3 \text{ A}$

Question ID : 5038903984
 Status : Answered
 Chosen Option : 4

Q.94 What does the given image show?

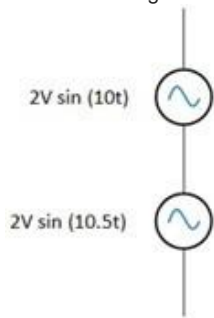

- Ans
- 1. DC sources in series with different angular frequency
 - 2. AC sources in series with different angular frequency
 - 3. AC sources in series with same angular frequency
 - 4. DC sources in series with same angular frequency

Question ID : 5038903948
Status : Answered
Chosen Option : 2

Q.95 Calculate the relative error wherein the measured value of the capacitor is $204.3 \mu\text{F}$, whereas its true value is $201.4 \mu\text{F}$.

- Ans
- 1. 1.43 percent
 - 2. 1.23 percent
 - 3. 1.68 percent
 - 4. 1.94 percent

Question ID : 5038903934
Status : Answered
Chosen Option : 2

Q.96 8086 has a/an _____ bit address bus.

- Ans
- 1. 8
 - 2. 16
 - 3. 20
 - 4. 32

Question ID : 5038903964
Status : Answered
Chosen Option : 3

Q.97

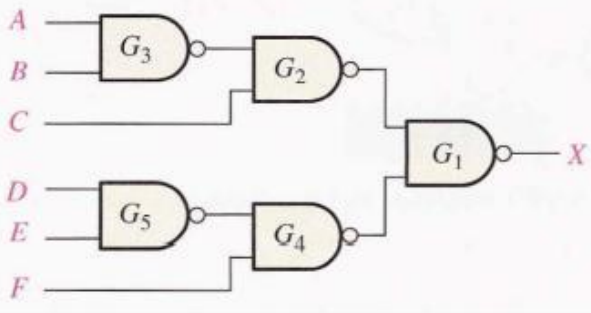

What should be the value of output X?

- Ans
- 1. $A'B+BC'+F$
 - 2. $(A'+B')C+(D'+E')F$
 - 3. $AB+(C+D)$
 - 4. $(A+B)+CF$

Question ID : 5038903901
 Status : Answered
 Chosen Option : 2

Q.98 Identify the missing component in the given figure.

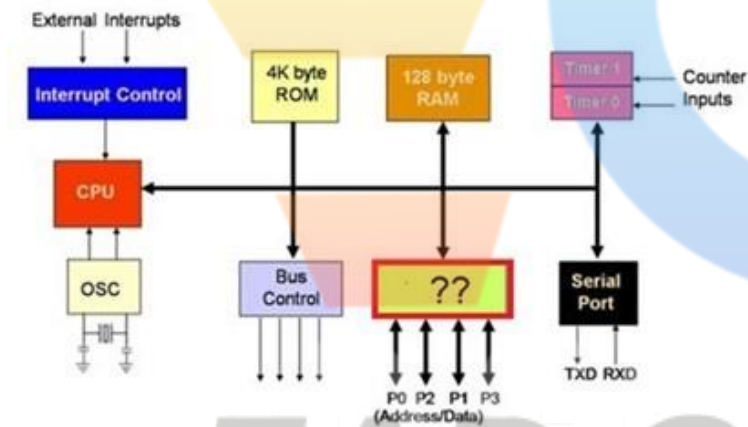

- Ans
- 1. I/O Ports
 - 2. Bus Control
 - 3. Parallel Port
 - 4. Serial Port

Question ID : 5038903968
 Status : Answered
 Chosen Option : 3

Q.99 _____ is a type of photo detector, which can convert optical signals into electrical signals.

- Ans
- 1. PIN diode
 - 2. Avalanche diode
 - 3. Zener diode
 - 4. Schottky diode

Question ID : 5038903919
 Status : Answered
 Chosen Option : 1

Q.100 The refractive index of the core is uniform throughout and undergoes an abrupt change at the cladding boundary which is known as _____.

- Ans
- 1. uniform-index fibre
 - 2. scale-index fibre
 - 3. graded-index fibre
 - 4. step-index fibre

Question ID : 5038903991
 Status : Not Answered
 Chosen Option : --

Q.101 In the given circuit, which of the following options does NOT hold true?

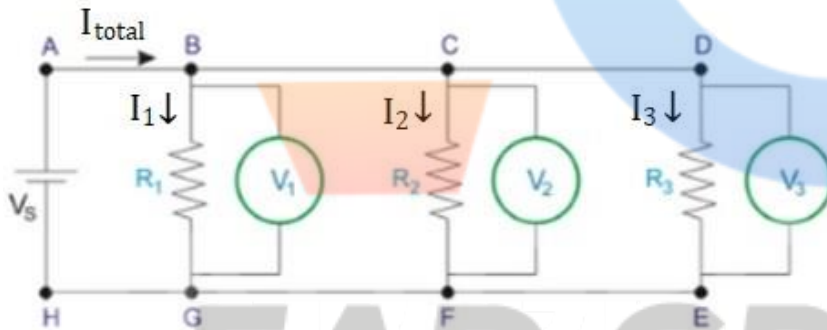

- Ans
- 1. $I_{total} = I_1 + I_2 + I_3$
 - 2. $\frac{1}{V_{(s)}} = \frac{1}{V_1} + \frac{1}{V_2} + \frac{1}{V_3}$
 - 3. $\frac{1}{R_{(total)}} = \frac{1}{R_1} + \frac{1}{R_2} + \frac{1}{R_3}$
 - 4. $V_S = V_1 = V_2 = V_3$

Question ID : 5038903923
 Status : Answered
 Chosen Option : 2

Q.102 For a tightly wound coil of wire, composed of N identical turns, each with the same Φ_B , ___ of induction states that $\varepsilon = - \frac{d\Phi_B}{dt}$ where N is the number of turns of wire and Φ_B is the magnetic flux through a single loop.

- Ans
- 1. Faraday's law
 - 2. Norton's law
 - 3. Kirchoff's law
 - 4. Thevenin's law

Question ID : 5038903946
Status : Answered
Chosen Option : 1

Q.103 Select the option that is true regarding the following two statements labelled Assertion (A) and Reason (R).
Assertion (A): Platinum and constantan are preferred materials used for fabricating rheostats.

Reason(R): High resistivity, high working temperature, high corrosion resistance, lowcost

- Ans
- 1. A is false but R is true
 - 2. Both A and R are true and R is the correct explanation of A
 - 3. Both A and R are true, but R is not a correct explanation of A
 - 4. A is true but R is false

Question ID : 5038903905
Status : Not Answered
Chosen Option : --

Q.104 The given properties define which magnetic circuit measure?

- Opposes the production of magnetic flux in a magnetic circuit.
- It is denoted by S.
- Its unit is AT/Wb or 1/Henry or H^{-1}

- Ans
- 1. Reluctance
 - 2. Permeance
 - 3. Conductance
 - 4. Magnetic flux

Question ID : 5038903913
Status : Answered
Chosen Option : 1

Q.105 A moving coil instrument has a resistance of $70\ \Omega$ and gives full scale deflection of 100 scale divisions for a current of 1 mA. The instrument is connected in parallel with a shunt of $30\ \Omega$ resistance and this combination is then connected in series with a load and supply. Determine the current in the load when the instrument gives an indication of 80 scale divisions.

- Ans
- 1. 1 mA
 - 2. 3.2 mA
 - 3. 2.66 mA
 - 4. 4 mA

Question ID : 5038903935

Status : **Not Attempted and Marked For Review**

Chosen Option : --

Q.106 _____ is defined as a measure of how easily a circuit or device will allow current to flow through it.

- Ans
- 1. Resistance
 - 2. Admittance
 - 3. Capacitance
 - 4. Impedance

Question ID : 5038903924

Status : **Answered**

Chosen Option : 1

Q.107 The Atmel ATmega164 is equipped with _____ RISC-type instructions.

- Ans
- 1. 131
 - 2. 84
 - 3. 125
 - 4. 120

Question ID : 5038903962

Status : **Not Answered**

Chosen Option : --

Q.108 The amplifier gain of the given circuit, for op-amp gain $A = 100,000$ and resistances $R_1 = 1.8 \text{ k}\Omega$ and $R_2 = 200 \Omega$, is given by:

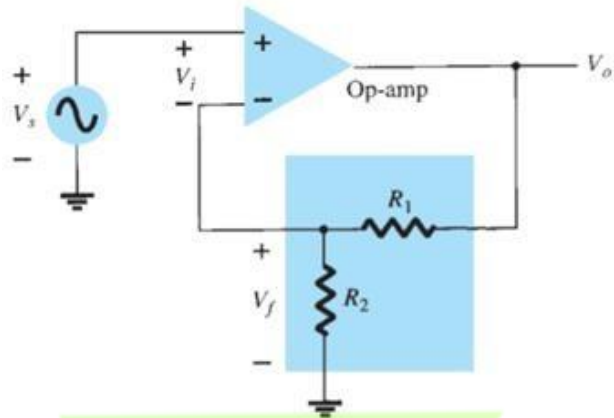

- Ans
- 1. $A_f = 1$
 - 2. $A_f = 100$
 - 3. $A_f = 12$
 - 4. $A_f = 10$

Question ID : 5038903931
 Status : Answered
 Chosen Option : 1

Q.109 Simplify $[AB'(C+BD) + A'B]C$.

- Ans
- 1. BC
 - 2. AB
 - 3. $B'C$
 - 4. $A'C$

Question ID : 5038903900
 Status : Answered
 Chosen Option : 3

EAD GROUP

Q.110

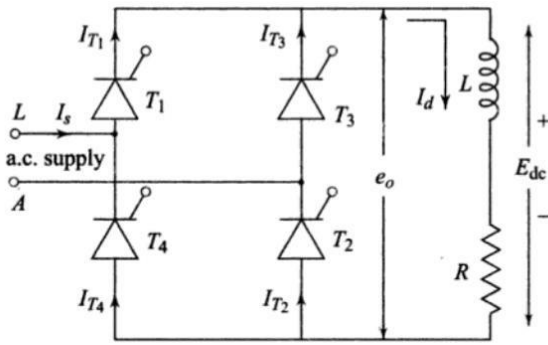

For the single phase fully controlled rectifier shown in the given figure, if the SCR3 is damaged and gets open circuited, calculate the average DC output voltage if a free-wheeling diode is connected and AC input voltage is 230 V. Firing

angle is maintained at $\frac{\pi}{3}$.

- Ans
- 1. 77.65 V
 - 2. 44.7 V
 - 3. 39 V
 - 4. 33.6 V

Question ID : 5038903951

Status : Answered

Chosen Option : 2

Q.111 ऊर्जा संरक्षण की आवश्यकता को समझने के बाद, राहुल ने अपनी दिनचर्या में विभिन्न तरीकों क बदलने और नए तरीकों को उपयोग करने का निर्णय लिया। उसने कार के बजाय स्कूल जाने के लिए साइकिल का उपयोग करना शुरू किया। घर पर उसने अपनी बहन से कहा कि जब वह इस्तेमाल में न हो तो कंप्यूटर और TV बंद कर दे। उसने अपने पिता से CFL बल्बों द्वारा अपने घर में सभी तापदीप्त बल्बों को बदलने के लिए भी कहा। उसने दिन के दौरान लाइट बंद करना शुरू कर दिया और दिन के प्रकाश का अधिक से अधिक उपयोग किया। हालांकि, क्योंकि राहुल को AC के ठंडे आराम से प्यार है, उसने अपने घर में केंद्रीकृत वातानुकूलन स्थापित करने का फैसला किया। अब, आपके अनुसार, कौन सी गतिविधि ऊर्जा संरक्षण से संबंधित नहीं है?

Ans

- 1. CFL बल्ब का उपयोग
- 2. उपयोग में न होने पर कंप्यूटर को स्विच ऑफ करना
- 3. घर का केंद्रीकृत वातानुकूलन
- 4. आवागमन के लिए साइकिल का उपयोग

Q.112 Which of the following is NOT an application of voltage in a parallel circuit? Ans

- 1. Power ring
- 2. Parallel capacitors
- 3. Voltage divider
- 4. Household appliances

Question ID : 5038903932

Status : Answered

Chosen Option : 1

Q.113 Which of the following programs transfers entire sixteen bytes of data from memory locations (XX50H to XX5FH) to a new memory location starting with XX70H?

Ans 1. LXI H,XX50H

```
LXI D,XX70H
MVI B,10H
NEXT: MOV A,M
STAX H
INX D
INX H
INX B
JNZ NEXT
HLT
```

2. LXI D, XX50H

```
LXI H, XX70H
MVI 10H, B
NEXT: MOV A,M
STAX D
INX H
INX D
DCR B
JNZ NEXT
HLT
```

3. LXI H,XX50H

```
LXI D,XX70H
MVI B,10H
NEXT: MOV A,M
STAX D
INX H
INX D
DCR B
JNZ NEXT
HLT
```

4. LXI H,XX50H

```
LXI D,XX70H
MVI B,10H
NEXT: MOV A,M
STAX D
DCR H
DCR D
INX B
JMP NEXT
HLT
```

Question ID : 5038903971

Status : Not Answered

Chosen Option : --

Q.114 _____ oscillators range from 20 KHz to 300 MHz. They can even be used for microwave applications as their capacitors provide low reactance path for the high-frequency signals.

Ans 1. Tuned collector

2. Colpitts

3. Wein bridge

4. Hartley

Question ID : 5038904025

Status : Answered

Chosen Option : 4

Q.115 _____ is defined as the unit of energy in joules which equals to the amount of work to be done for bringing one electron against an electric field of potential difference 1 volt.

- Ans
- 1. 1 V
 - 2. 1 kWh
 - 3. 1 eV
 - 4. 1 W

Question ID : 5038903888
Status : Answered
Chosen Option : 3

Q.116 Which option best describes the meaning of 'entrepreneur', which is originally a French word?

- Ans
- 1. to undertake
 - 2. to perform
 - 3. to support
 - 4. to entertain

Question ID : 5038903952
Status : Answered
Chosen Option : 1

Q.117 What will be the output of the following?

```
#include
#include

int main()
{
    union newtest {int
        i;
        float f;
        char c;
    };
    union newtest* t;
    t = (union newtest*)malloc(sizeof(union newtest));t->f
    = 18.90f;
    printf("%f", t->f);
    return 0;
}
```

- Ans
- 1. 18.900000
 - 2. Newtest
 - 3. Syntax error
 - 4. 18.90

Question ID : 5038904005
Status : Not Answered
Chosen Option : --

Q.118 Distortion factor is also known as:

- Ans
- 1. noise factor
 - 2. fundamental distortion
 - 3. harmonic distortion
 - 4. total harmonic distortion

Question ID : 5038904021
Status : Answered
Chosen Option : 3

Q.119 Which of the following is an advantage of electrodynamic type power factor meters? Ans

- 1. Working forces are small as compared to moving iron type instruments.
- 2. The scale is not extended over 360° .
- 3. They have high torque to weight ratio.
- 4. Calibration of electrodynamic type instruments are highly affected by changing the supply voltage frequency.

Question ID : 5038904031
Status : Answered
Chosen Option : 3

Q.120



The given symbol represents which of the following?

- Ans
- 1. light dependent resistor
 - 2. voltage divider
 - 3. Current divider
 - 4. amplifier

Question ID : 5038903908
Status : Answered
Chosen Option : 1

Q.121 Determine the percentage power saved when carrier and one of the sidebands are suppressed in an AM wave modulated to a depth of 50%.

- Ans
- 1. 76%
 - 2. 83.3%
 - 3. 55%
 - 4. 94.4%

Question ID : 5038903994
Status : Answered
Chosen Option : 2

Q.122 Determine the output of the following.

```
#include
int main()
{
  int a[6]={1,2,3,4,5,6};
  switch(sizeof(a))
  {
  case1:
  case2:
  case3:
  case4:
  case5:
  printf("hello");Break;
  }
  printf("HI");
  return 0;
}
```

- Ans
- 1. Hello
 - 2. HI
 - 3. hello
 - HI
 - 4. helloHI

Question ID : 5038903885
Status : Not Answered
Chosen Option : --

Q.123 Observe the given image and find I_T .

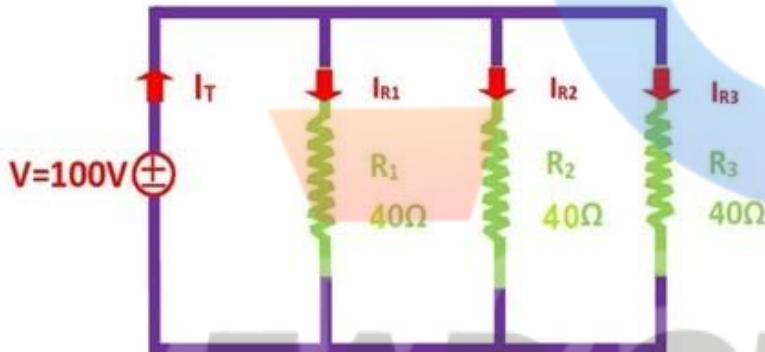

- Ans
- 1. 4 A
 - 2. 1.2 A
 - 3. 7.5 mA
 - 4. 7.5 A

Question ID : 5038903921
Status : Answered
Chosen Option : 4

Q.124 _____ is a graphical representation that provides a systematic method for simplifying the Boolean expressions.

- Ans
- 1. B-tree
 - 2. Logic Gate
 - 3. Truth Table
 - 4. K-map

Question ID : 5038904028
Status : Answered
Chosen Option : 4

Q.125 Fibre is preferred over electrical cabling when _____ bandwidth, _____ distance or _____ to electromagnetic interference is required.

- Ans
- 1. low, long, immunity
 - 2. low, short, stability
 - 3. high, long, immunity
 - 4. high, short, stability

Question ID : 5038903989
Status : Answered
Chosen Option : 3

Q.126 Which of the following is NOT an advantage of interconnected electrical grid system?

- Ans
- 1. The grid system can improve the diversity factor of each generating station connected to the grid.
 - 2. The grid covers a smaller number of consumers than that of an individual generating station.
 - 3. The arrangement can exchange the peak load of a plant.
 - 4. The interconnected grid increases the reliability of power system.

Question ID : 5038903915
Status : Answered
Chosen Option : 4

Q.127 रैना अपनी स्मार्टवाच पहनता है और जॉगिंग के लिए पार्क में जाता है। आज पार्क से वापस लौटते समय, उसने एटीएम से ₹5,000 निकाले। वह अपने मोबाइल फोन पर लेखा शेष की पुष्टि के लिए बैंक शाखा में जाता है।

निम्नलिखित में से क्या, अंतःस्थापित प्रणाली का अनुप्रयोग नहीं है?

ANS

- 1. स्मार्टवाच
- 2. ATM
- 3. बैंक की शाखा
- 4. मोबाइल फोन

Q.128 Global positioning system (GPS) uses:

- Ans
- 1. CDMA
 - 2. SDMA
 - 3. TDMA
 - 4. FDMA

Question ID : 5038904024
Status : Answered
Chosen Option : 1

Q.129 The result of $11100111 - 00010011$ is:

- Ans
- 1. 10101110
 - 2. 01101010
 - 3. 11010100
 - 4. 00000101

Question ID : 5038903897
Status : Answered
Chosen Option : 3

Q.130 In microprocessor terminology, what does DMA stand for? Ans

- 1. Direct Memory Advice
- 2. Direct Memory Access
- 3. Dual Memory Access
- 4. Direct Memorable Access

Question ID : 5038903966
Status : Answered
Chosen Option : 2

Q.131 Which of the following is NOT true about magnetic flux lines? Ans

- 1. No two flux lines cross each other.
- 2. Each magnetic flux line is a closed loop.
- 3. It is the total number of magnetic lines of force in the field.
- 4. Two similar lines of force travel side by side and attract each other.

Question ID : 5038903986
Status : Answered
Chosen Option : 2

Q.132 नीचे दी गई शर्तों, एक उपग्रह के स्थिर दिखाई देने के लिए हैं। गलत स्थिति को पहचानें।

- Ans
- 1. इसकी गति की दिशा पृथ्वी की धुरी की दिशा के समान होनी चाहिए।
 - 2. इसकी कक्षा, पृथ्वी के भूमध्यरेखीय तल में होनी चाहिए।
 - 3. इसका नाम 'S' से शुरू होना चाहिए।
 - 4. समयावधि 24 घंटे होनी चाहिए।

Q.133 The boosting of higher modulating frequencies in accordance with a prearranged curve is called:

Question ID :
5038904007

- Ans
- 1. pre-emphasis
 - 2. curve fitting
 - 3. de-emphasis
 - 4. Reconstruction

Question ID : 5038903995
Status : Answered
Chosen Option : 1

Q.134 Find the odd one.
Hint: Transducer

- Ans
- 1. Loudspeakers
 - 2. Microphones
 - 3. Microchips
 - 4. Radiation Sensors

Question ID : 5038903950
Status : Answered
Chosen Option : 3

EAD GROUP

Q.135 Calculate the current I in the given circuit.

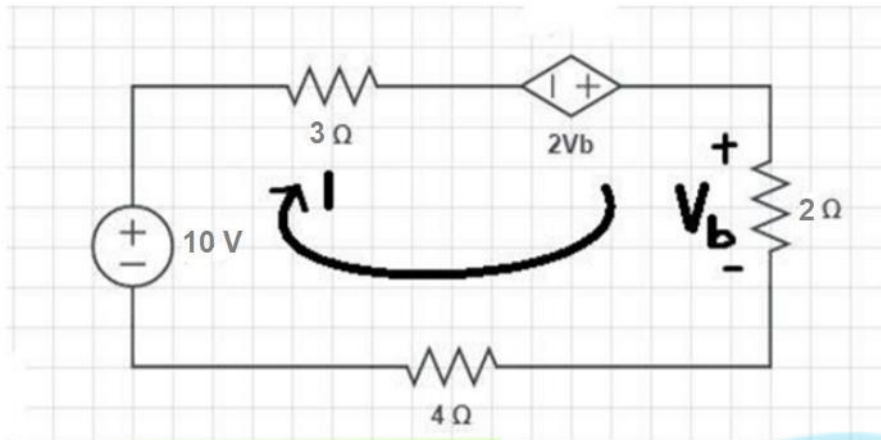

- Ans
- 1. 5 A
 - 2. 0.5 A
 - 3. 2 A
 - 4. 2 mA

Question ID : 5038903928
 Status : Answered
 Chosen Option : 3

Q.136 The given image represents which logic gate?

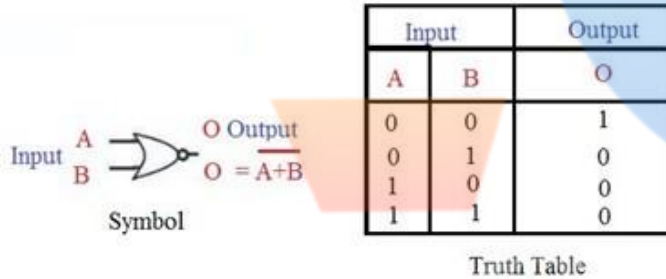

- Ans
- 1. NOR Gate
 - 2. XOR Gate
 - 3. OR Gate
 - 4. NAND Gate

Question ID : 5038904020
 Status : Answered
 Chosen Option : 1

Q.137 Degenerate mode in rectangular waveguides is:

- Ans
- 1. TM_{m0} ($m=0, n=1$)
 - 2. TE_{m0} and TM_{m0} (both $m \neq 0$)
 - 3. TE_{m0} and TM_{m0} (both $m \neq 0, n=0$)
 - 4. TE_{m0} ($m=1, n=0$)

Question ID : 5038903975
 Status : Answered
 Chosen Option : 3

Q.138 In 8051, by default:

- Ans
- 1. only timer/counter0 interrupt is disabled
 - 2. all interrupts are disabled
 - 3. only System RESET interrupt is disabled
 - 4. only timer/counter1 interrupt is disabled

Question ID : 5038903960
Status : Not Answered
Chosen Option : --

Q.139 आदेशित सामग्री सूची की मात्रा जो कुल सामग्री सूची की लागत को कम करेगी, कहलाती है।

- Ans
- 1. EOQ
 - 2. JIT
 - 3. BOM
 - 4. ABC

Question ID : 5038903955
Status : Not Answered
Chosen Option : --

Q.140 As per the amended EC Act, the minimum connected load for a building should be:Ans

- 1. 150 kW
- 2. 120 kW
- 3. 300 kW
- 4. 100 kW

Question ID : 5038903943
Status : Answered
Chosen Option : 4

Q.141 Calculate the percentage error introduced in the calculated value of Q by 0.02Ω insertion resistance in a coil with a resistance of 10Ω connected in direct connection in a Q meter. Resonance occurs when oscillator frequency is 1 MHz and resonating capacitor is set at 65 pF.

- Ans
- 1. 0.2 percent
 - 2. 5 percent
 - 3. 1.5 percent
 - 4. 0.8 percent

Question ID : 5038903938
Status : Not Attempted and Marked For Review
Chosen Option : --

Q.142 75 Q प्रतिरोधक में शक्ति विसरण को 90 वाट तक सीमित करने के लिए, प्रतिरोध ज्ञात करें और 75Q प्रतिरोधक के साथ 120 V स्रोत में श्रृंखला में जोड़े जाने वाले प्रतिरोधक का शक्ति विसरण ज्ञात करें।

Ans

- 1. 34.6 Ω , 41.5 W
- 2. 30 Ω , 40 W
- 3. 23 Ω , 28 W
- 4. 15 Ω , 33 W

Question ID : 5038903909

Status : **Not Attempted and Marked For Review**

Chosen Option : --

Q.143 For satellite communication the standard uplink and downlink frequencies, respectively, in C-band are :

Ans

- 1. 6 GHz and 4 GHz
- 2. 12 GHz and 8 GHz
- 3. 4 GHz and 6 GHz
- 4. 12 GHz and 9 GHz

Question ID : 5038903972

Status : **Answered**

Chosen Option : 2

Q.144 Determine the number of bits/sec generated by a PCM system if the bandwidth of TV video and audio signal of 4.5 MHz is to be converted to PCM stream with 1024 quantization levels. Assume signal is sampled at 20% above Nyquist rate.

Ans

- 1. 108×10^6
- 2. 18×10^4
- 3. 80×10^6
- 4. 81×10^5

Question ID : 5038903998

Status : **Not Attempted and Marked For Review**

Chosen Option : --

Q.145 Find the odd one.

Ans

- 1. int
- 2. float
- 3. char
- 4. pint

Question ID : 5038904003

Status : **Answered**

Chosen Option : 4

Q.146 दी गई संकलप्रक्रिया

को सही क्रम में व्यवस्थित करें।

- a. संयोजन (लिंकिंग)
- b. कोडांतरण (असेम्बलिंग)
- c. संकलन (कम्पायलिंग)
- d. पूर्व संसाधन (प्री प्रोसेसिंग)

Ans ✓ 1. d->c->b->a

✗ 2. a->c->b->d

✗ 3. d->c->a->b

✗ 4. a->b->c->d

Question ID : 5038904001

Status : Answered

Chosen Option : 3

Q.147 Which of the following is NOT an advantage of LVDT?

Ans ✗ 1. Infinite resolution

✗ 2. Low hysteresis

✗ 3. Linearity

✓ 4. Limited dynamic response

Question ID : 5038903945

Status : Answered

Chosen Option : 4

Q.148 The disadvantage of using the observation method for market surveys is that: Ans

✗ 1. it is not biased on the respondent

✗ 2. it is based on secondary data

✓ 3. behaviour of the consumer is not easily predictable

✗ 4. information requires modification

Question ID : 5038903953

Status : Not Answered

Chosen Option : --

Q.149 Determine the normalized resultant pattern of the array of two directional (point sources) short collinear dipoles shown.

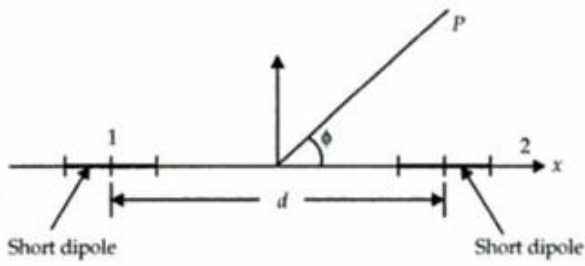

Ans

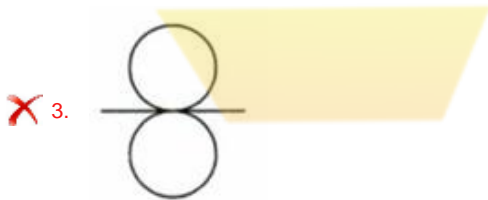

LEAD GROUP

Question ID : 5038903973
 Status : Not Answered
 Chosen Option : --

Q.150 Convert hex number to decimal.

(0101)₁₆

- Ans
- 1. 572
 - 2. 527
 - 3. 257
 - 4. 253

Question ID : 5038903965
Status : Answered
Chosen Option : 3

Section : General Knowledge or Awareness

Q.1 Which Article of the Constitution of India provides for 'Equality before Law'?Ans

- 1. Article 14
- 2. Article 30
- 3. Article 19
- 4. Article 21

Question ID : 5038904051
Status : Answered
Chosen Option : 4

Q.2 निम्न में से किसने अपने भाइयों की हत्या कर अपने पिता को नजरबंद कर दिया था?

Ans

- 1. औरंगजेब
- 2. हुमायूँ
- 3. अकबर
- 4. बहादुर शाह

Q.3 मुगल साम्राज्य के उस सेनापति का नाम क्या था, जिसने अकबर के शासन के शुरुआती दौर में उसकी देखभाल तथा मार्गदर्शन किया था, जब अकबर ने 14 वर्ष की उम्र में गद्दी संभाली थी ?

ANS

- 1. टोडरमल
- 2. अधम खान
- 3. मान सिंह
- 4. बैरम खान

Q.4 A Financial Bill may only be introduced in Lok Sabha, on the recommendation of the:Ans

- 1. Finance Minister
- 2. Speaker of the Lok Sabha
- 3. Prime Minister
- 4. President

Question ID : 5038904050
Status : Answered
Chosen Option : 1

Q.5 निम्न में से कौन अंतर इंजन (डिफरेंस इंजन) और विश्लेषिक इंजन (एनालिटिकल इंजन) के आविष्कारक हैं, जिससे कंप्यूटर के विकास का मार्ग प्रशस्त हुआ?

Ans

- 1. स्टीव जॉब्स
- 2. मैनी फर्नांडीज
- 3. चार्ल्स बैबेज
- 4. बिल गेट्स

Q.6 सिमलीपाल बायो- रिजर्व (अभयारण्य) निम्न में से किस राज्य में स्थित है?

Ans1.

- 1. नागालैंड
- 2. ओडिशा
- 3. मिजोरम
- 4. हिमाचल प्रदेश

Q.7 Who among the following was appointed secretary-general of the National Human Rights Commission (NHRC) on 7 October 2020?

Ans

- 1. Apurva Chandra
- 2. MA Ganapathy
- 3. Bimbadhar Pradhan
- 4. Seema Gupta

Question ID : 5038904046
Status : Answered
Chosen Option : 2

Q.8 Who is the author of the book 'The Underground Railroad', which won the Pulitzer Prize for fiction in 2017?

- Ans
- 1. Dylan Thomas
 - 2. M John Harrison
 - 3. Colson Whitehead
 - 4. Maggie O'Farrell

Question ID : 5038904048
Status : Not Answered
Chosen Option : --

Q.9 किसिमिलपाल पवत ढूंखला की सबसे ऊँची चोटी कौन-सी

- है? Ans
- 1. धौली (Dhaulii)
 - 2. देवमाली (Deomali)
 - 3. नियमिगर (Niyamgiri)
 - 4. खैरीबु (Khairiburu)

Question ID : 5038904042
Status : Not Answered
Chosen Option : --

Q.10 भारत के किस राज्य में एक वर्ष 'रण उाव' का आयोजन होता

- है? Ans
- 1. महारा
 - 2. गुजरात
 - 3. म देश
 - 4. राजस्थान

Question ID : 5038904035
Status : Answered
Chosen Option : 2

Q.11 किस मसे कौन पेशेवर टेनिस खिलाड़ी

- नहीं है? Ans
- 1. पूरव राजा
 - 2. विशाल उल
 - 3. िंसपाल िसंह
 - 4. अंकिता रैना

Question ID : 5038904052
Status : Answered
Chosen Option : 3

Q.12 Which international cricketer became the first cricketer to violate ICC's saliva ban rule in July 2020?

- Ans
- 1. Jofra Archer
 - 2. Rishabh Pant
 - 3. Dominic Sibley
 - 4. Mohammad Amir

Question ID : 5038904053
Status : Not Answered
Chosen Option : --

Q.13 Who was the first Indian to become a British Member of Parliament during the British rule in India?

- Ans
- 1. Gopal Krishna Gokhale
 - 2. C Rajagopalachari
 - 3. Dadabhai Naoroji
 - 4. Acharya JB Kriplani

Question ID : 5038904045
Status : Answered
Chosen Option : 3

Q.14 Who appoints the chairman of the Union Public Service Commission? Ans

- 1. The Prime Minister
- 2. The Vice President of India
- 3. The President of India
- 4. The Speaker of Lok Sabha

Question ID : 5038904049
Status : Answered
Chosen Option : 3

Q.15 What is the maximum cost of a project admissible under the manufacturing sector in the Prime Minister's Employment Generation Programme (PMEGP)?

- Ans
- 1. Rs.50 lakh
 - 2. Rs.20 lakh
 - 3. Rs.15 lakh
 - 4. Rs.25 lakh

Question ID : 5038904036
Status : Answered
Chosen Option : 4

Q.16 निम्न में से कौन-से हिन्दुस्तानी शास्त्रीय संगीत प्रतिपादक किराना घराना से संबंधित हैं?

Ans

- 1. पंडित शिव कुमार शर्मा
- 2. उस्ताद जाकिर हुसैन
- 3. पंडित भीमसेन जोशी
- 4. उस्ताद बिस्मिल्लाह खाँ

Q.17 Where did the foreign ministers of Australia, India, Japan and the US meet on 6 October 2020 for a highly anticipated 'Quad' ministerial meeting?

Ans

- 1. Tokyo
- 2. Canberra
- 3. New Delhi
- 4. Washington, D.C.

Question ID : 5038904047

Status : Answered

Chosen Option : 3

Q.18 What is demonetization?

Ans

- 1. It involves introducing a new currency in the economy.
- 2. It involves reducing the official value of a currency in relation to other currencies.
- 3. It involves stripping a currency unit of its status as legal tender.
- 4. It involves increasing the official value of a currency in relation to other currencies.

Question ID : 5038904037

Status : Answered

Chosen Option : 3

Q.19 _____ अति अभिक्रियाशील हैलोजन है।

Ans .

- 1. फ्लोरीन
- 2. क्लोरीन
- 3. ब्रोमीन
- 4. आयोडीन

Question ID : 5038904039

Status : Answered

Chosen Option : 1

EAD GROUP

Q.20 भारत में पूर्वी घाट की सबसे ऊंची चोटी कौन-सी है?

- Ans 1. धौलागिरि
 2. कलसूबाई
 3. डोड्डा बेट्टा
 4. महेंद्रगिरि

Question ID : 5038904040
Status : Not Answered
Chosen Option : --

Section : Reasoning

Q.1 Select the option that is related to the third word in the same way as the second word is related to the first word.

Goat : Bleat :: Camel : ?

- Ans 1. Beat
 2. Grunt
 3. Bray
 4. Croak

Question ID : 5038904068
Status : Answered
Chosen Option : 2

Q.2 चार शब्द-युग्म दिए गए हैं, जिनमें से तीन किसी न किसी तरह समान हैं और एक असंगत है। उस असंगत युग्म का चयन कीजिए।

- Ans X 1. अफ़गानिस्तान - काबुल
2. पाकिस्तान - कराची
X 3. चीन - बीजिंग
X 4. नेपाल - काठमांडू

Q.3 Select the option that can replace the question mark (?) in the following letter-clusterseries.
GPB, HSG, IVL, ?

- Ans 1. JYO
 2. KYQ
 3. JYQ
 4. KXP

Question ID : 5038904054
Status : Answered
Chosen Option : 3

Q.4 निम्नलिखित शब्दों को उस क्रम में विन्यासित कीजिए जिसमें वे अंग्रेजी शब्दकोश में दिखते हैं।

2. reindeer
3. reimburse
4. reinforcement
5. reincarnation

- Ans
- 1. 3, 5, 1, 2, 4
 - 2. 3, 5, 2, 4, 1
 - 3. 3, 5, 1, 4, 2
 - 4. 1, 2, 3, 4, 5

Question ID : 5038904059
Status : Answered
Chosen Option : 2

Q.5 चार शब्द-युग्म दिए गए हैं, जिनमें से तीन किसी न किसी तरह समान हैं और एक असंगत है। उस असंगत युग्म का चयन कीजिए।

Ans

- 1. उत्तराखंड - नंदा देवी
- 2. राजस्थान - गुरु शिखर
- 3. केरल - कंचनजंगा
- 4. गुजरात - गिरनार

Question ID : 5038904062
Status : Answered
Chosen Option : 4

Q. 6 उस विकल्प का चयन कीजिए जिसके अक्षर-समूह के त्रिक के मध्य वही संबंध है जो दिए गए अक्षर- समूह के त्रिक के मध्य है। (ADG, BEH, CFI)

- Ans
- 1. (GJN, HLO, IMQ)
 - 2. (SVY, TWZ, UXZ)
 - 3. (MPU, NQS, ORT)
 - 4. (JMP, KNQ, LOR)

Question ID : 5038904073
Status : Answered
Chosen Option : 4

Q.7 उस विकल्प का चयन कीजिए जिसके अक्षर-समूहों के युग्म के मध्य वही संबंध है जो दिए गए अक्षर- समूहों के युग्म के मध्य है।SPN : UTT

- Ans
- 1. LTM : NXT
 - 2. MCP : OGT
 - 3. FDS : HHY
 - 4. GMP : IOV

Question ID : 5038904071
Status : Answered
Chosen Option : 3

Q.8 उस विकल्प का चयन कीजिए जिसका तीसरे वाक्यांश से वही संबंध है जो दूसरे वाक्यांश का पहले वाक्यांश से है। द डिस्कवरी ऑफ इंडिया : जवाहरलाल नेहरू :: माइ एक्स्पेरीमेंट्स विद टुथ : ?

- Ans
- 1. सुभाष चंद्र बोस
 - 2. महात्मा गांधी
 - 3. रबींद्रनाथ टैगोर
 - 4. भगत सिंह

Question ID : 5038904067
Status : Answered
Chosen Option : 2

Q.9 उस विकल्प का चयन कीजिए जिसका तीसरे अक्षर-समूह से वही संबंध है जो दूसरे अक्षर-समूह का पहले अक्षर-समूह से है।

Ans
LXP : OCK :: NGT : ?

- Ans
- 1. MTG
 - 2. MTU
 - 3. QAV
 - 4. PTH

Question ID : 5038904065
Status : Answered
Chosen Option : 3

10 अक्षर-समूहों के चार युग्म दिए गए हैं, जिनमें से तीन किसी न किसी तरह समान हैं और एक असंगत है। उस असंगत युग्म का चयन कीजिए।

- Ans
- 1. (LEG, OIL)
 - 2. (LDP, OHU)
 - 3. (COF, FSK)
 - 4. (MVB, PYE)

Question ID : 5038904061
Status : Answered
Chosen Option : 4

Q.11 उस विकल्प का चयन कीजिए जो निम्नांकित अक्षरांकीय श्रृंखला में प्रश्नवाचक चिह्न (?) के स्थान पर आ सकता है।

JB7, MG14, PL21, ?

- Ans
- 1. SQ28
 - 2. SV35
 - 3. TQ21
 - 4. RV28

Question ID : 5038904057
Status : Answered
Chosen Option : 1

Q.12 उस विकल्प का चयन कीजिए जिसके शब्दों के मध्य वही संबंध है जो दिए गए शब्द-युग्म के शब्दों के मध्य है।

Ans

दीपिका कुमारी : तीरंदाजी

- Ans
- 1. पी. वी. सिंधु: बैडमिंटन
 - 2. मिताली राज : टेनिस
 - 3. मैरीकॉम : कुश्ती
 - 4. गीता फोगाट : मुक्केबाजी

Question ID : 5038904069
Status : Answered
Chosen Option : 1

Q.13 उस विकल्प का चयन कीजिए जो निम्नांकित अक्षर-समूह की श्रृंखला में प्रश्नवाचक चिह्न (?) के स्थान पर आ सकता है। TVA, QQH, NLO, ?

- Ans
- 1. LGW
 - 2. KGV
 - 3. JHU
 - 4. JGV

Question ID : 5038904055
Status : Answered
Chosen Option : 2

Q.14 उस विकल्प का चयन कीजिए जिसके शब्दों के मध्य वही संबंध नहीं है जो दिए गए शब्द-युग्म के शब्दों के मध्य है।

बंदी : स्वतंत्र

Ans

- 1. मुड़ा हुआ: सीधा
- 2. उदार : सख्त
- 3. भयावह डरावना
- 4. अनुपस्थित: उपस्थित

Question ID : 5038904070
Status : Answered
Chosen Option : 3

Q.15 Select the option that is related to the third word in the same way as the second word is related to the first word.

Pedology : Soil :: Nephology : ?

- Ans
- 1. Shell
 - 2. Brain
 - 3. Kidney
 - 4. Cloud

Question ID : 5038904066
Status : Answered
Chosen Option : 4

Q.16 उस विकल्प का चयन कीजिए जिसके अक्षर-समूह के त्रिक के मध्य वही संबंध है जो दिए गए अक्षर-समूह के त्रिक के मध्य है।
(BY, EV, HS)

- Ans
- 1. (DV, GT, IR)
 - 2. (FU, IR, LO)
 - 3. (PK, SG, VE)
 - 4. (JP, MN, PK)

Question ID : 5038904072
Status : Answered
Chosen Option : 2

Q.17 उस विकल्प का चयन कीजिए जो निम्नांकित अक्षरांकीय श्रृंखला में प्रश्नवाचक चिह्न (?) के स्थान पर आ सकता है।

C 10 G, E14 I, H20L, L28P, ?

- Ans
- 1. P 30 V
 - 2. Q 38U
 - 3. Q 36 V
 - 4. K 32 W

Question ID : 5038904056
Status : Answered
Chosen Option : 2

Q.18 निम्नलिखित शब्दों को अर्थपूर्ण क्रम में विन्यासित कीजिए और सही क्रम का चयन कीजिए।

Ans

1. एक करोड़ शंख (Quadrillion)
2. दस खरब (Trillion) 3. क्वाइंटिलियन (Quintillion)
4. दस लाख (Million)Ans

- 1. 1, 2, 3, 4, 5
- 2. 5, 3, 2, 1, 4
- 3. 4, 5, 2, 1, 3
- 4. 4, 2, 5, 3, 1

Question ID : 5038904060
Status : Answered
Chosen Option : 3

Q.19 उस अक्षर-समूह का चयन कीजिए जो निम्नांकित श्रृंखला से संबंधित नहीं है।
TNC, PPG, LQK, HTO, DVS

- Ans
- 1. PPG
 - 2. HTO
 - 3. LQK
 - 4. DVS

Question ID : 5038904058
Status : Answered
Chosen Option : 3

Q.20 चार अक्षर-समूह दिए गए हैं, जिनमें से तीन किसी न किसी तरह समान हैं और एक असंगत है। उस असंगत अक्षर-समूह का चयन कीजिए।

- Ans
- 1. SUWY
 - 2. JLNP
 - 3. BDFH
 - 4. DEGI

Question ID : 5038904064
Status : Answered
Chosen Option : 4

Section : General Hindi

Q.1 उद्धृत का विलोम शब्द

है-

- Ans
- 1. विनीत
 - उदार
 - 3. दयालु
 - 4. कुलीन

Question ID : 5038904080
Status : Answered
Chosen Option : 1

Q.2 भुलक्कड़ में किस प्रत्यय का प्रयोग हुआ है?

- Ans
- 1. कड़
 - 2. अक्कड़
 - 3. ड
 - 4. लक्कड़

Question ID : 5038904077
Status : Answered
Chosen Option : 2

Q.3 निम्नलिखित में से वह शब्द पहचाने जो क्रिया विशेषण है? है?

- Ans
- 1. खट्टा
 - 2. प्रेमपूर्वक
 - 3. दयालु
 - 4. सुर

Question ID : 5038904078
Status : Answered
Chosen Option : 1

Q.4 निम्नलिखित में से कौन सा शब्द पुलिंग नहीं है?

- Ans 1. वरण
 2. वकालत
 3. वजन
 4. विकल्प

Q.5 तनमनधन में कौन सा समास है?

- Ans 1. अव्ययी भाव
 2. द्विगु
 3. द्वंद्व
 4. तत्पुरुष

Q.6 अभिलाष में किस उपसर्ग का प्रयोग हुआ है?

- Ans 1. लाष
 2. अ
 3. अभि
 4. अभ

Q.7 यथासमय में कौन सा समास है?

- Ans 1. द्विगु
 2. अव्ययी भाव
 3. द्वंद्व
 4. त ष

Question ID : 5038904076
Status : Answered
Chosen Option : 3

Question ID : 5038904074
Status : Answered
Chosen Option : 2

Q.8 गरल' का विलोम शब्द होगा-

- Ans 1. सूखा
 2. तरल
 3. सुधा
 4. सरल

Question ID : 5038904081
Status : Answered
Chosen Option : 2

Q.9 चूना लगाना' मुहावरे का सही अर्थ है-

- Ans 1. प्रशंसा करना
 2. सेवा करना
 3. श्रम करना
 4. धोखा देना

Q. 10 'सुधि - सुधी शब्द-युग्म का सही अर्थ

- Ans 1. इच्छा - विद्वान
 2. होश- बुद्धिमान
 3. विद्वान - स्मरण
 4. स्मरण - बलवान

Question ID : 5038904082
Status : Answered
Chosen Option : 2

EAD GROUP